

# 100/1000BASE-T1 MEDIA CONVERTER H- MTD

## USER MANUAL

July 2022

Manual-version: 1.6

Firmware: 1.0.0

Hardware: v2.4 and higher

## Content

<b>1</b>	<b>Product description</b>	<b>4</b>
1.1	Functionality	4
1.1.1	Features	4
1.1.2	General information	4
1.1.3	Links	5
1.1.4	General operating and safety strategy of TE products	5
1.1.5	General design rules for the power supply of TE products	5
1.2	Warranty and safety information	6
1.3	RoHS certificate of compliance	8
1.4	Scope of delivery	8
1.5	Changelog hardware	8
<b>2</b>	<b>Hardware interfaces</b>	<b>9</b>
2.1	Connectors	9
2.1.1	RJ-45 connector (1)	9
2.1.2	H-MTD connector (2)	9
2.1.3	Power MQS connector (3)	10
2.1.4	Debug connector (4)	11
2.2	DIP switches (5)	11
2.3	Status LEDs (6)	11
2.3.1	Resetting error LED	12
<b>3</b>	<b>Configuration</b>	<b>13</b>
3.1	Configuration through Power MQS connector	13
3.1.1	Link status output (LS) (PIN 2)	14
3.1.2	Force link down (LD) (PIN 3)	14
3.1.3	Force slave mode (FS) (PIN 4)	14
3.2	Frame generator	14
<b>4</b>	<b>Standard use-case</b>	<b>16</b>
<b>5</b>	<b>Used 100/1000BASE-T1 filter</b>	<b>17</b>
<b>6</b>	<b>Additional information</b>	<b>18</b>
6.1	Disclaimer	18
<b>7</b>	<b>List of figures</b>	<b>19</b>
<b>8</b>	<b>Changelog</b>	<b>20</b>

<b>9</b>	<b>Contact .....</b>	<b>21</b>
<b>10</b>	<b>Declaration of conformity.....</b>	<b>22</b>

# 1 Product description

## 1.1 Functionality



Figure 1-1: 100/1000BASE-T1 Media Converter H-MTD

Automotive ethernet though similar in functionality has some differences in comparison to standard ethernet. To interact between the two technologies, a converter is needed. The **Technica Engineering 100/1000BASE-T1 MediaConverter H-MTD** is a physical layer converter providing conversion between 100/1000BASE-T1 and 100 BASE-TX or 1000BASE-T with a constant delay of about 2  $\mu$ s.

### 1.1.1 Features

- 1 Port 100/1000Base-T1 Ethernet with Marvell 88Q2112 A2 transceiver, 100/1000 MBit/s Full duplex on a single unshielded twisted pair with H-MTD connector
- 1 Port 100BASE-TX / 1000BASE-T1 Ethernet with RJ-45 connector
- Robust steel case
- 4 DIP switches for easy configuration
- Support of 1000BASE-T1 Marvell IEEE Mode (See [CHAPTER 6.1](#)) and Marvell Legacy Mode
- Frame generator

### 1.1.2 General information

Voltage requirement:	6 to 30 Volt DC (nominal 12/24 Volt DC)
Power consumption:	2 Watt
Size WxLxH:	89 x 72 x 28 mm
Weight:	0,22 kg
International Protection:	IP 2 0
Operating temperature:	-40° to +80 °Celsius

**Latency:** ( $\pm 0.1 \mu\text{s}$ ) tolerance

Direction	Mode	Latency [ $\mu\text{s}$ ]
BASE-T1 to Fast Ethernet	100Mbps	1.6
Fast Ethernet to BASE-T1	100Mbps	1.2
BASE-T1 to Ethernet	1Gbps and Legacy/ IEEE mode (See <a href="#">CHAPTER 6.1</a> )	2.5
Ethernet to BASE-T1	1Gbps and Legacy/ IEEE mode (See <a href="#">CHAPTER 6.1</a> )	2.7

Table 1-1: Latency tolerance

### 1.1.3 Links

The user can download the latest documentation for the 100/1000BASE-T1 Media Converter H-MTD [here](#).

### 1.1.4 General operating and safety strategy of TE products

Technica Engineering’s products are designed for operation in automotive systems and for supply voltages of nominal 12 V or 24 V. The applicable limit, values adhere to the standard norms for 12 V or 24 V automotive onboard power systems correspondingly and can be found in the mentioned norms.

Should Technica Engineering’s products be operated in voltage ranges beyond those specified in the norms, which represents a breach of the conditions of operation, then this will void the product warranty and Technica Engineering will assume no liability whatsoever for the results and/or consequences thereof.

This is especially valid whenever the voltage level reaches or exceeds the limits of the low-voltage directive. In this case, damage to the devices cannot be excluded. Due to the manufacturing characteristics of the devices, there is no imminent fire hazard from the device itself, if the devices are being operated in an environment according to the conditions of use. A secondary fire hazard cannot be excluded, should those conditions not be met. Protection against overvoltage cannot be provided in such a breach of the conditions of use.

### 1.1.5 General design rules for the power supply of TE products



The power supply solution of Technica Engineering’s products is equipped with a self-protection mechanism. This automatic function protects the internal electronic components against excessive temperature and too high supply voltage by switching the device off. This automatic switch-off function is independent of any software function. Excessive temperatures in the device can be caused by high environmental





temperatures or internal failures of the device. The device can protect itself by shutting down its power supply avoiding further damage to itself.

The operator/user of these devices must take measures for the right protection of the power supply lines and the according to the connector. The maximum power consumption of the Technica Engineering products is written in this user manual.

Please consider that some of the products are working with a step-up converter. So, the current needed in case of undervoltage conditions must be considered higher than a nominal voltage level. The user must choose the right fuse and/or other over current protection measures.

## 1.2 Warranty and safety information

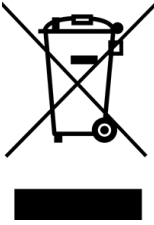
	<p>Before operating the device, read this manual thoroughly and retain it for your reference. The latest documentation for the 100/1000BASE-T1 Media Converter H-MTD can be downloaded <a href="#">here</a>.</p>
	<p>Use the device only as described in this manual. Use only in dry conditions. Do not insert any foreign object in the slots/openings of the housing. Do not apply power to a damaged device. The device may only be used by specialists.</p>
	<p>Do not open the device. Otherwise, the warranty will be lost.</p>

	<p>This product is intended for use in automobiles or automotive-like environments. An automotive-like environment includes test setups or test benches in the office, laboratory, and workshop areas. In the test setups, the same environmental conditions apply as in-vehicle electrical systems. Technica Engineering products are not intended to be used as standard IT equipment. The test systems and products from Technica Engineering are designed as a customer and application-specific test modules that are only used by specialists for the development and test facilities.</p> <p>When integrating the modules in a vehicle or test set-up, the user must ensure appropriate ventilation or air convection. Technica Engineering products must not be considered as a safety element out of context when using safety-critical systems and must be included in the safety assessment when used. The development class in a safety system must be considered with standard QM referred to as ISO26262.</p>
	<p> The device can get hot.</p> <p>Do not cover the device due to fire danger. Do not place the device near highly flammable materials due to fire danger. Do not use the device above the specified operating temperature. The operating temperature is the ambient temperature of the installation space.</p>
	<p>This symbol is only valid in the European Union. If you wish to discard this product, please contact your local authorities or dealer, and ask for the correct method of disposal. Technica Engineering GmbH is registered as a manufacturer of the brand "Technica Engineering" and the device type "Small devices of Information- and Telecommunications- technology for exclusive use in non-private Households". WEEE Reg. No. DE 20776859</p>
	<p>Please refer to <a href="#">CHAPTER 10</a> for the EU Declaration of Conformity in accordance with Directive 2014/30/EU.</p>

## 1.3 RoHS certificate of compliance

Technica Engineering's 100/1000BASE-T1 Media Converter H-MTD complies with RoHS (Restriction of Hazardous Substances Directive), see Certificate of Compliance in [CHAPTER 10](#).

## 1.4 Scope of delivery

The delivery includes:

- 1x 100/1000BASE-T1 Media Converter H-MTD

Cable-set can be ordered separately:

- 1x Cable set
  - 1m Ethernet Cable
  - Connectors and crimp contacts,
  - LCA-101-2000-Z-Rosenberger Cable Assembly
  - 4mm banana plugs

 For details consult the cable set document.

## 1.5 Changelog hardware

Version	Change	Date
1.0	First release	Aug 2020
2.4	Hardware revision	July 2022



## 2 Hardware interfaces

### 2.1 Connectors

Here you can see an overview of all HW interfaces of the 100/1000BASE-T1 Media Converter H-MTD on the front side and backside.

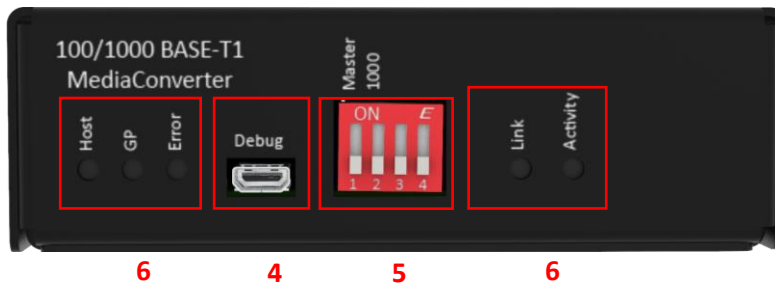

Figure 2-1: Front side of Media Converter H-MTD

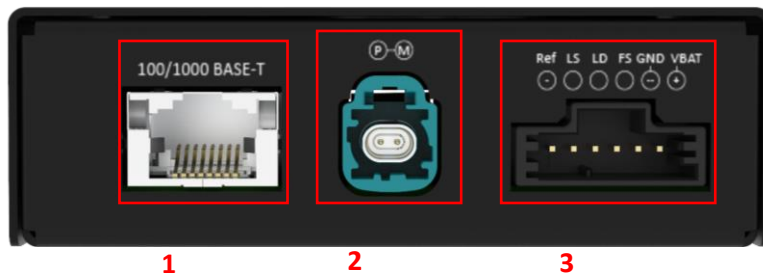

Figure 2-2: Backside of Media Converter H-MTD

#### 2.1.1 RJ-45 connector (1)

This is a standard RJ-45 connector to be used with CAT5e STP cable for 100BASE-TX or 1000BASE-T connections.

#### 2.1.2 H-MTD connector (2)

Name	Picture	Part Number
Rosenberger H-MTD Stecker		E6K10A-1CAZ5-Z

Table 2-1: Parts of Rosenberger H-MTD Connector

**Pinning:**



Pin	Function
1	Data Line Plus (Positive)
2	Data Line Minus (Negative)

Figure 2-3: H-MTD Connector

Table 2-2: H-MTD Connector

This is a shielded connector. The shield in the device is connected to the ground at 10 Ohm and 10 nF.

### 2.1.3 Power MQS connector (3)



Name	Picture	Part Number
TE connectivity 6pos MQS .63 header 90deg THR		1-1418888-5
TE connectivity MQS BU-GEH 6P		1-969508-2 Distributor: mouser.de
TE connectivity MQS crimp contact		928999-1 Distributors: Mouser.de; Digikey.de

Table 2-3: Parts of Tyco MQS Connector

**Pinning:**

Pin	Function
1	Reference GND only
2	Link Status Output (3V3, Active Low) (LS)
3	Force LinkDown Input (Active Low) (LD)
4	ForceSlave Mode (Active Low) (FS)
5	Power GND
6	VBAT (6 to 30 Volt DC)

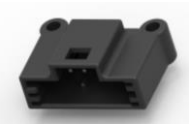
Table 2-4: Power MQS connector

For more information about PINs 2, 3, and 4 connected to the power MQS connector (1), please see [CHAPTER 3.1](#).

## 2.1.4 Debug connector (4)

The debug connector can be used as a serial interface to interact with the device. This interface enables the user to read TX/RX register counters, SQI values of the channels, CRC errors, and other information. It can also be used for bootloader updates of the device.

A USB-B cable is needed for connection to the service connector. This is not part of the delivery and cannot be ordered.

 This is not a video interface.

```

--- Counter ----- Count ---
Base-T1 Link Drops           0
Base-T1 Errored Blocks       0
Base-T1 Received Packets*    37592
Base-T1 Sent Packets         Not available
Base-T1 CRC Error            0

* The received packets value increases but may drop packets due to a limitation
of the PHY. Check the User Manual for more information.
[App_MDCONV]#> █

```

Figure 2-4 Example of information from debug connector

## 2.2 DIP switches (5)

These DIP switches are for configuration. You can find more information about configuration in [CHAPTER 3](#).

## 2.3 Status LEDs (6)

The 100/1000BASE-T1 Media Converter H-MTD has 5 LEDs on the front side of the case.

LED	Description
<b>Host LED</b>	Will blink slowly (once a second), during normal operation of the device.
<b>GP LED</b>	General-purpose LED. will be lit when the PHYs are configured. If the PHYs fail to get configured this LED will be off.
<b>Error LED (red)</b>	Will be lit when at least one CRC error is detected. This may happen when the H-MTD connector is plugged during operation.
<b>Link LED</b>	100 or 1000Base-T1 Link active.

<b>Activity LED</b>	100 or 1000Base-T1 Ethernet data transmission.
---------------------	--

Table 2-5 LEDs Description

 If the GP LED is ON and Host LED is off, this indicates an error state.

The 100/1000BASE-T1 Media Converter H-MTD has LEDs integrated with the RJ-45 connector.

For RJ45 connection:

Left side: Green = 100 BASE-TX link Orange = 1000 BASE-T link	Right side: Orange = Activity
---	----------------------------------

### 2.3.1 Resetting error LED

If the error LED is lit red, a disconnection of the link can clear the LED. This can be done by changing the DIP switch position to break the link and changing it back to form a link again.

## 3 Configuration

The 100/1000BASE-T1 Media Converter H-MTD is configured by four DIP switches on the front side of the device.

DIP Switch	Status	Description
1	ON (up)	BASE-T1 Port is set to Master
	OFF (down)	BASE-T1 Port is set to Slave
2	ON (up)	1000BASE-T1 to 1000BASE-T conversion
	OFF (down)	100BASE-T1 to 100BASE-TX conversion
3	ON (up)	1000BASE-T1 Marvell legacy mode (A0)
	OFF (down)	1000BASE-T1 IEEE compliant mode (A2) (See <a href="#">CHAPTER 6.1</a> ).
		<b>i</b> This DIP switch has no function when DIP2 is OFF
4	ON (up)	Frame Generator active on 100/1000BASE-T1. (see <a href="#">CHAPTER 3.2</a> ).
	OFF (down)	Normal operation

Table 3-1: Configuration of DIP Switches

**i** For establishing a BASE-T1 link one device must be set as Master and the other must be set as Slave.

**i** It is not possible to mix the two speeds of the ports. If the Media converter is configured for 100BASE-T1, the RJ-45 connector is always 100BASE-TX. If the media converter is configured for 1000BASE-T1 the RJ-45 connector is 1000BASE-T.

### 3.1 Configuration through Power MQS connector

The PINs 2, 3, and 4 of the Power MQS connector ([CHAPTER 2.1.3](#)) can be used for configuration and link status output.

### 3.1.1 Link status output (LS) (PIN 2)

The Link Status PIN 2 outputs a weak 3.3 Volts status signal. There is an integrated 5K Ohm pull-up resistor to 3.3 Volts. This PIN is active Low. The pull-down transistor can drain up to 100mA.

### 3.1.2 Force link down (LD) (PIN 3)

If you connect PIN 3 and PIN 1 by a shortcut wire link down is forced. These pins are active low. There is an integrated 5K Ohm Pullup to 3.3 Volts. For normal operation please disconnect the PINs.

**i** While removing the shortcut of PIN 3 and PIN 1, a full reset of the device will be done.

### 3.1.3 Force slave mode (FS) (PIN 4)

If you connect PIN 4 and PIN 1 by a shortcut wire Force Slave mode is activated. These pins are active low. There is an integrated 5K Ohm Pullup to 3.3 Volts. For normal operation please disconnect the PINs.

**i** Activated Force Slave mode overrides the DIP switch configuration.

**i** Force Slave mode must be applied before powering up. Otherwise, a power reset is needed.

## 3.2 Frame generator

The 100/1000BASE-T1 Media Converter H-MTD in frame generator mode is working only on the BASE-T1 port as a frame generator. The generated frame is in total 1514 bytes long and is sent with

- Roundabout 12 Mbps in 100BASE-T1 mode
- Roundabout 120 Mbps in 1000BASE-T1 mode

The frame contains no specific MAC source or destination. All bytes have the same pattern: 0xA5 and 0x5A in alternation.

No.	Time	Source	Destination	Protocol	Length	Info
1	0.000000	a5:5a:a5:5a:a5:5a	a5:5a:a5:5a:a5:5a	0xa55a	1514	Ethernet II
2	0.000001	a5:5a:a5:5a:a5:5a	a5:5a:a5:5a:a5:5a	0xa55a	1514	Ethernet II
3	0.000001	a5:5a:a5:5a:a5:5a	a5:5a:a5:5a:a5:5a	0xa55a	1514	Ethernet II
4	0.000001	a5:5a:a5:5a:a5:5a	a5:5a:a5:5a:a5:5a	0xa55a	1514	Ethernet II
5	0.000002	a5:5a:a5:5a:a5:5a	a5:5a:a5:5a:a5:5a	0xa55a	1514	Ethernet II
6	0.000002	a5:5a:a5:5a:a5:5a	a5:5a:a5:5a:a5:5a	0xa55a	1514	Ethernet II

<						
> Frame 1: 1514 bytes on wire (12112 bits), 1514 bytes captured (12112 bits)						
v Ethernet II, Src: a5:5a:a5:5a:a5:5a (a5:5a:a5:5a:a5:5a), Dst: a5:5a:a5:5a:a5:5a (a5:5a:a5:5a:a5:5a)						
> Destination: a5:5a:a5:5a:a5:5a (a5:5a:a5:5a:a5:5a)						
> Source: a5:5a:a5:5a:a5:5a (a5:5a:a5:5a:a5:5a)						
Type: Unknown (0xa55a)						
v Data (1500 bytes)						
Data: a55aa55aa55aa55aa55aa55aa55aa55aa55aa55aa55aa55aa55aa55aa55aa...						
[Length: 1500]						

0000	a5 5a a5 5a a5 5a a5 5a a5 5a a5 5a a5 5a a5 5a	.Z.Z.Z.Z.Z.Z.Z.Z.Z.Z.Z.Z.Z.Z.Z.Z
0010	a5 5a a5 5a a5 5a a5 5a a5 5a a5 5a a5 5a a5 5a	.Z.Z.Z.Z.Z.Z.Z.Z.Z.Z.Z.Z.Z.Z.Z.Z
0020	a5 5a a5 5a a5 5a a5 5a a5 5a a5 5a a5 5a a5 5a	.Z.Z.Z.Z.Z.Z.Z.Z.Z.Z.Z.Z.Z.Z.Z.Z
0030	a5 5a a5 5a a5 5a a5 5a a5 5a a5 5a a5 5a a5 5a	.Z.Z.Z.Z.Z.Z.Z.Z.Z.Z.Z.Z.Z.Z.Z.Z
0040	a5 5a a5 5a a5 5a a5 5a a5 5a a5 5a a5 5a a5 5a	.Z.Z.Z.Z.Z.Z.Z.Z.Z.Z.Z.Z.Z.Z.Z.Z
0050	a5 5a a5 5a a5 5a a5 5a a5 5a a5 5a a5 5a a5 5a	.Z.Z.Z.Z.Z.Z.Z.Z.Z.Z.Z.Z.Z.Z.Z.Z
0060	a5 5a a5 5a a5 5a a5 5a a5 5a a5 5a a5 5a a5 5a	.Z.Z.Z.Z.Z.Z.Z.Z.Z.Z.Z.Z.Z.Z.Z.Z

Figure 3-1: Frame by Frame Generator

## 4 Standard use-case

Here you can see a standard use-case of the 100/1000BASE-T1 Media Converter H-MTD:

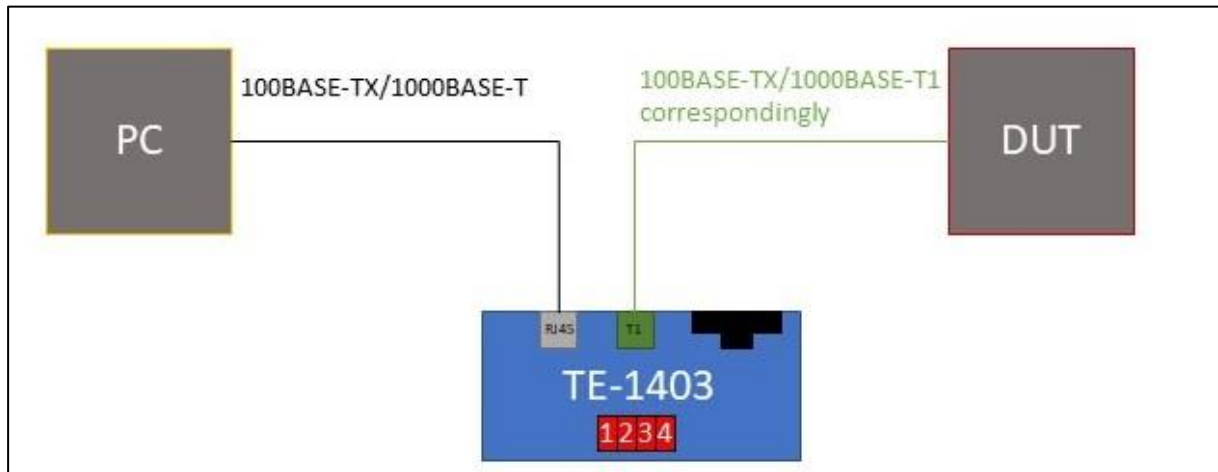

Figure 4-1: Example of a use case

MC	<b>Media Converter</b>
DUT	<b>Device Under Test</b>

- DIP Switch 1: **Master/Slave** setting, is dependent on the DUT. If DUT is Master, MC must be configured as Slave, DIP Switch 1 must be OFF [down], and vice versa.
- DIP Switch 2: **100/1000 speed** setting is dependent on the speed of the DUT. If it is a 100BASE-T1 connection DIP Switch 2 must be OFF [down] and vice versa.
- DIP Switch 3: **Legacy/IEEE mode** setting: If the PHY of the DUT is a Marvell PHY A0 (Only 1000BASE-T1) then the DIP Switch 3 must be ON [up]. If it is any other IEEE 1000BASE-T1 conform PHY the DIP Switch must be OFF [down]. (See [CHAPTER 6.1](#)).
- DIP Switch 4: **Frame Generator** function, always must be OFF [down]. Only in Frame Generator-Mode, the DIP Switch must be ON [up], in this case, the device no longer works as a converter



## 5 Used 100/1000BASE-T1 filter

The following 1000BASE-T1 filter is used in the 100/1000BASE-T1 Media Converter H-MTD:

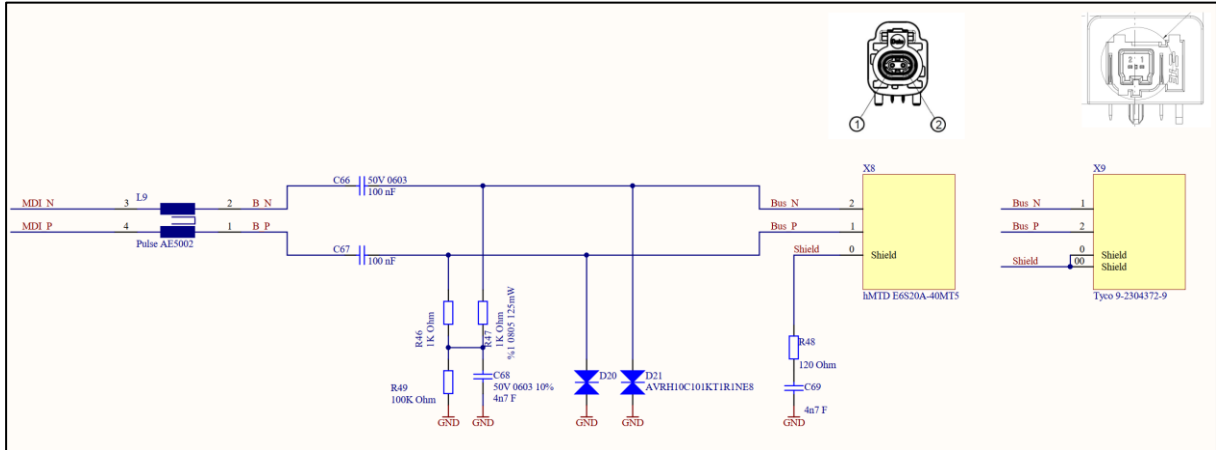

Figure 5-1: Used Filter in 100/1000BASE-T1 Media Converter

## 6 Additional information

- The 100/1000BASE-T1 Media Converter H-MTD is optimized for automotive use. The maximum cable length for 100/1000BASE-T1 segments is limited to 15 meters
- It is not possible to mix different speeds from RJ-45 to BASE-T1-port
- Don't use it as [Frame Generator](#) while converting. Data loss may occur.

### 6.1 Disclaimer

The **“IEEE Compliant mode”** is defined by the chip vendor. Technica Engineering cannot be held responsible for the interoperability of this chip and hence the complete product with other devices if the interoperability issues are caused by the **“IEEE Compliant mode”**.

## 7 List of figures

Figure 1-1: 100/1000BASE-T1 Media Converter H-MTD .....	4
Figure 2-1: Front side of Media Converter H-MTD .....	9
Figure 2-2: Backside of Media Converter H-MTD.....	9
Figure 2-3: H-MTD Connector .....	10
Figure 2-2 Example of information from debug connector .....	11
Figure 3-1: Frame by Frame Generator .....	15
Figure 4-1: Example of a use case .....	16
Figure 5-1: Used Filter in 100/1000BASE-T1 Media Converter .....	17

## 8 Changelog

Version	Chapter	Description	Date
<b>1.0</b>	All	First release	May 2020
<b>1.1</b>	10	Declaration of Conformity added	July 2020
<b>1.2</b>	All	Updates	Sept 2020
<b>1.3</b>	2.1	Images updated	Oct 2020
	2.3.1	Resetting Error LED	
	10	Declaration of conformity updated	
<b>1.4</b>	6.1	Disclaimer for Marvell IEEE Mode added	Mar 2021
<b>1.5</b>	All	Minor changes & formatting	Feb 2022
<b>1.6</b>	All	Adaptions for Hardware 2.4	July 2022

## 9 Contact

If you have any questions regarding this product, please feel free to contact us:

Technica Engineering GmbH  
Leopoldstr. 236  
80807 München  
Germany

Technical support:  
[support@technica-engineering.de](mailto:support@technica-engineering.de)

General information:  
[Info@technica-engineering.de](mailto:Info@technica-engineering.de)

Most current user manuals and product information:  
<https://technica-engineering.de/en/>

## 10 Declaration of conformity

### Български

С настоящото Technica Engineering GmbH декларира, че продуктът Модул за улавяне 100/1000BASE-T1 Media Converter H-MTD (TE-1403), е в съответствие с Директива 2015/863/EU and 2014/30/EC. Цялостният текст на ЕС декларацията за съответствие може да се намери на следния интернет адрес:

<https://technica-engineering.de/wp-content/uploads/2020/08/100-1000base-t1-mediaconverter-hmtd-te-1403-eu-declaration-of-conformity.pdf>

### Čeština

Tímto Technica Engineering GmbH prohlašuje, že produkt 100/1000BASE-T1 Media Converter H-MTD (TE-1403), je v souladu se směrnicí 2015/863/EU and 2014/30/EU. Úplné znění EU prohlášení o shodě je k dispozici na této internetové adrese:

<https://technica-engineering.de/wp-content/uploads/2020/08/100-1000base-t1-mediaconverter-hmtd-te-1403-eu-declaration-of-conformity.pdf>

### Dansk

Hermed erklærer Technica Engineering GmbH, at produktet 100/1000BASE-T1 Media Converter H-MTD (TE-1403), er i overensstemmelse med Direktiv 2015/863/EU and 2014/30/EU. EU-overensstemmelseserklæringens fulde tekst kan findes på følgende internetadresse:

<https://technica-engineering.de/wp-content/uploads/2020/08/100-1000base-t1-mediaconverter-hmtd-te-1403-eu-declaration-of-conformity.pdf>

### Deutsch

Hiermit erklärt Technica Engineering GmbH, dass das Produkt 100/1000BASE-T1 Media Converter H-MTD (TE-1403) die Richtlinie 2015/863/EU and 2014/30/EU entspricht. Der vollständige Text der EU-Konformitätserklärung ist unter der folgenden Internetadresse verfügbar:

<https://technica-engineering.de/wp-content/uploads/2020/08/100-1000base-t1-mediaconverter-hmtd-te-1403-eu-declaration-of-conformity.pdf>

### Eesti

Käesolevaga deklareerib Technica Engineering GmbH, et toode hõivamismoodul 100/1000BASE-T1 Media Converter H-MTD (TE-1403), vastab direktiivi 2015/863/EU and 2014/30/EL nõuetele. ELi vastavusdeklaratsiooni tielik tekst on kttasaadav jrgmisel internetiaadressil:

<https://technica-engineering.de/wp-content/uploads/2020/08/100-1000base-t1-mediaconverter-hmtd-te-1403-eu-declaration-of-conformity.pdf>

### English

Hereby, Technica Engineering GmbH declares that the product 100/1000BASE-T1 Media Converter H-MTD (TE-1403), complies with Directive 2015/863/EU and 2014/30/EU. The full text of the EU declaration of conformity is available at the following internet address:

<https://technica-engineering.de/wp-content/uploads/2020/08/100-1000base-t1-mediaconverter-hmtd-te-1403-eu-declaration-of-conformity.pdf>

### Español

Por la presente, Technica Engineering GmbH declara que el producto 100/1000BASE-T1 Media Converter H-MTD (TE-1403), es conforme con la Directiva 2015/863/EU and 2014/30/UE. El texto completo de la declaración UE de conformidad está disponible en la página web siguiente:

<https://technica-engineering.de/wp-content/uploads/2020/08/100-1000base-t1-mediaconverter-hmtd-te-1403-eu-declaration-of-conformity.pdf>

### Ελληνικά

Με την παρούσα ο/η Technica Engineering GmbH, ότι το προϊόν 100/1000BASE-T1 Media Converter H-MTD (TE-1403), πληροί την οδηγία 2015/863/EU and 2014/30/EE. Το πλήρες κείμενο της δήλωσης συμμόρφωσης ΕΕ διατίθεται στην ακόλουθη ιστοσελίδα στο διαδίκτυο:

<https://technica-engineering.de/wp-content/uploads/2020/08/100-1000base-t1-mediaconverter-hmtd-te-1403-eu-declaration-of-conformity.pdf>

### Français

Le soussigné, Technica Engineering GmbH, déclare que le produit 100/1000BASE-T1 Media Converter H-MTD (TE-1403), est conforme la directive 2015/863/EU and 2014/30/UE. Le texte complet de la

déclaration UE de conformité est disponible l'adresse internet suivante:

<https://technica-engineering.de/wp-content/uploads/2020/08/100-1000base-t1-mediaconverter-hmtd-te-1403-eu-declaration-of-conformity.pdf>

## Hrvatski

Technica Engineering GmbH ovime izjavljuje da je proizvod 100/1000BASE-T1 Media Converter H-MTD (TE-1403) u skladu s Direktivom 2015/863/EU and 2014/30/EU. Cjeloviti tekst EU izjave o sukladnosti dostupan je na sljedećoj internetskoj adresi:

<https://technica-engineering.de/wp-content/uploads/2020/08/100-1000base-t1-mediaconverter-hmtd-te-1403-eu-declaration-of-conformity.pdf>

## Italiano

Il fabbricante, Technica Engineering GmbH, dichiara che il prodotto 100/1000BASE-T1 Media Converter H-MTD (TE-1403), conforme alla direttiva 2015/863/EU and 2014/30/UE. Il testo completo della dichiarazione di conformità UE disponibile al seguente indirizzo Internet:

<https://technica-engineering.de/wp-content/uploads/2020/08/100-1000base-t1-mediaconverter-hmtd-te-1403-eu-declaration-of-conformity.pdf>

## Latviešu

Ar šo Technica Engineering GmbH deklarē, ka produkts 100/1000BASE-T1 Media Converter H-MTD (TE-1403), atbilst Direktīvai 2015/863/EU and 2014/30/ES. Pilns ES atbilstības deklarācijas teksts ir pieejams šādā interneta vietnē:

<https://technica-engineering.de/wp-content/uploads/2020/08/100-1000base-t1-mediaconverter-hmtd-te-1403-eu-declaration-of-conformity.pdf>

## Lietuvių

Aš, Technica Engineering GmbH, patvirtinu, kad produktas sugavimo modulis 100/1000BASE-T1 Media Converter H-MTD (TE-1403), atitinka Direktyvą 2015/863/EU and 2014/30/ES. Visas ES atitikties deklaracijos tekstas prieinamas šiuo internet adresu:

<https://technica-engineering.de/wp-content/uploads/2020/08/100-1000base-t1-mediaconverter-hmtd-te-1403-eu-declaration-of-conformity.pdf>

## Magyar

Technica Engineering GmbH igazolja, hogy a termék 100/1000BASE-T1 Media Converter H-MTD (TE-1403) a 2015/863/EU and

2014/30/EU irányelvnek. Az EÜmegfelelőségi nyilatkozat teljes szövege elérhető a következő internetes címen:

<https://technica-engineering.de/wp-content/uploads/2020/08/100-1000base-t1-mediaconverter-hmtd-te-1403-eu-declaration-of-conformity.pdf>

## Malti

B'dan, Technica Engineering GmbH, niddikjara li l-prodott 100/1000BASE-T1 Media Converter H-MTD (TE-1403), huwa konformi madDirettiva 2015/863/EU and 2014/30/UE. It-test kollu tad-dikjarazzjoni ta' konformit tal-UE huwa disponibbli f'dan l-indirizz talInternet li ġej:

<https://technica-engineering.de/wp-content/uploads/2020/08/100-1000base-t1-mediaconverter-hmtd-te-1403-eu-declaration-of-conformity.pdf>

## Nederlands

Hierbij verklaar ik, Technica Engineering GmbH, dat het 100/1000BASE-T1 Media Converter H-MTD (TE-1403) product voldoet aan richtlijn 2015/863/EU and 2014/30/EU. De volledige tekst van de EUconformiteitsverklaring kan worden geraadpleegd op het volgende internetadres:

<https://technica-engineering.de/wp-content/uploads/2020/08/100-1000base-t1-mediaconverter-hmtd-te-1403-eu-declaration-of-conformity.pdf>

## Polski

Technica Engineering GmbH niniejszym oświadcza, że produkt 100/1000BASE-T1 Media Converter H-MTD (TE-1403), jest zgodny z dyrektywą 2015/863/EU and 2014/30/UE. Pełny tekst deklaracji zgodności z UE jest dostępny pod następującym adresem internetowym:

<https://technica-engineering.de/wp-content/uploads/2020/08/100-1000base-t1-mediaconverter-hmtd-te-1403-eu-declaration-of-conformity.pdf>

## Português

O(a) abaixo assinado(a) Technica Engineering GmbH declara que o produto 100/1000BASE-T1 Media Converter H-MTD (TE-1403), está em conformidade com a Diretiva 2015/863/EU and 2014/30/UE. O texto integral da declaração de conformidade está disponível no seguinte endereço de Internet:

<https://technica-engineering.de/wp-content/uploads/2020/08/100-1000base-t1-mediaconverter-hmtd-te-1403-eu-declaration-of-conformity.pdf>

### Română

Prin prezenta Technica Engineering GmbH declară ca produsul 100/1000BASE-T1 Media Converter H-MTD (TE-1403), este în conformitate cu Directiva 2015/863/EU and 2014/30/UE. Textul integral al declarației UE de conformitate este disponibil la următoarea adresă internet:

<https://technica-engineering.de/wp-content/uploads/2020/08/100-1000base-t1-mediaconverter-hmtd-te-1403-eu-declaration-of-conformity.pdf>

### Slovensko

Technica Engineering GmbH potrjuje, da je izdelek 100/1000BASE-T1 Media Converter H-MTD (TE-1403), skladen z irektivo 2015/863/EU and 2014/30/EU. Celotno besedilo izjave EU o skladnosti je na voljo na naslednjem spletnem naslovu:

<https://technica-engineering.de/wp-content/uploads/2020/08/100-1000base-t1-mediaconverter-hmtd-te-1403-eu-declaration-of-conformity.pdf>

### Slovensky

Technica Engineering GmbH týmto vyhlasuje, že produkt 100/1000BASE-T1 Media Converter H-MTD (TE-1403), je v slade so smernicou 2015/863/EU and 2014/30/EÚ. Úplné EÚ vyhlásenie o zhode je k dispozícii na tejto internetovej adrese:

<https://technica-engineering.de/wp-content/uploads/2020/08/100-1000base-t1-mediaconverter-hmtd-te-1403-eu-declaration-of-conformity.pdf>